

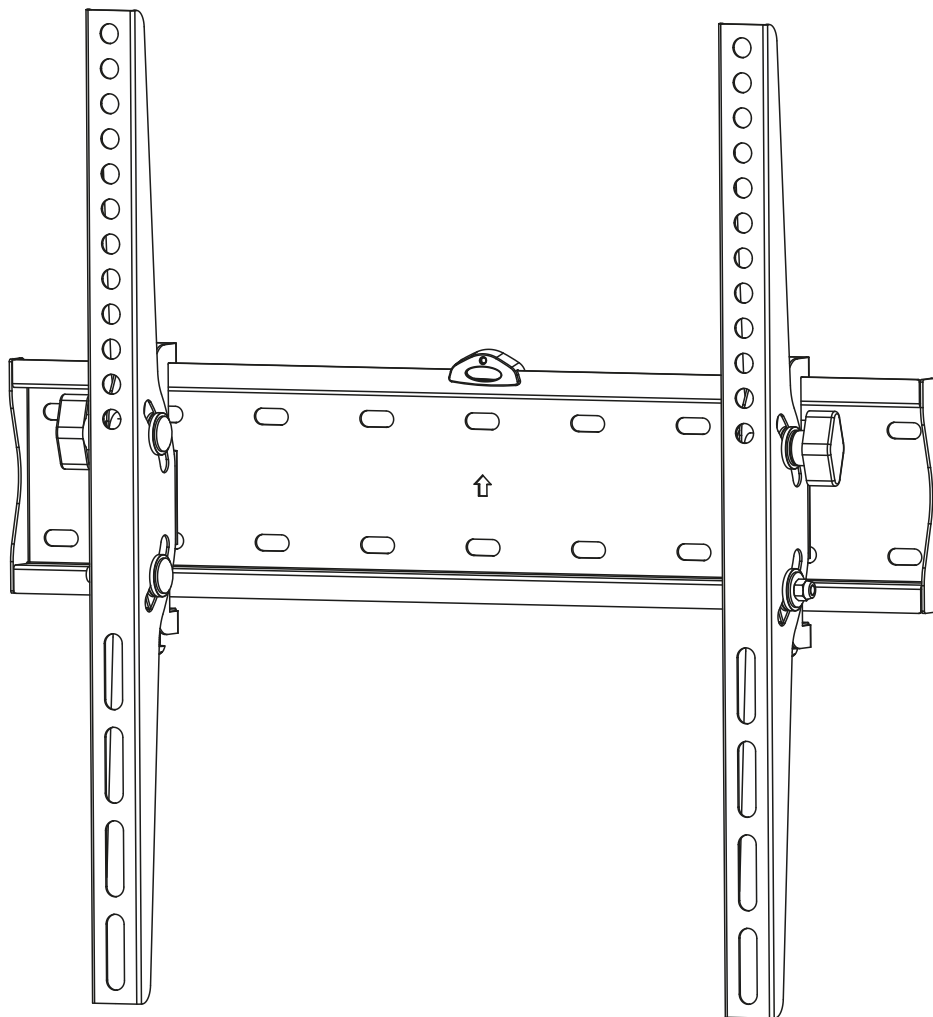

MANUAL DE INSTALACIÓN



SKU: F40T

- EN**  Read the entire instruction manual before you start installation and assembly. If you have any questions regarding any of the instructions or warnings, please contact your local distributor for assistance.
- CAUTION:** Use with products heavier than the rated weights indicated may result in instability causing possible injury.
- Mounts must be attached as specified in assembly instructions. Improper installation may result in damage or serious personal injury.
 - Safety gear and proper tools must be used. This product should only be installed by professionals.
 - Make sure that the supporting surface will safely support the combined weight of the equipment and all attached hardware and components.
 - Use the mounting screws provided and DO NOT OVER TIGHTEN mounting screws.
 - This product contains small items that could be a choking hazard if swallowed. Keep these items away from children.
 - This product is intended for indoor use only. Using this product outdoors could lead to product failure and personal injury.
- IMPORTANT:** Ensure that you have received all parts according to the component checklist prior to installation. If any parts are missing or faulty, telephone your local distributor for a replacement.
- MAINTENANCE:** Check that the bracket is secure and safe to use at regular intervals (at least every three months).

A (x1)



B (x1)



C (x1)

M6x30

M8x30

D8

Ø15xØ8x15

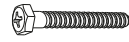

W-A (x4)
ST6.3x55



W-B (x4)
Ø10x45



W-C (x4)
D6

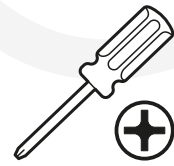
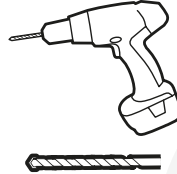
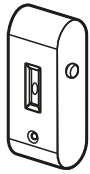

1

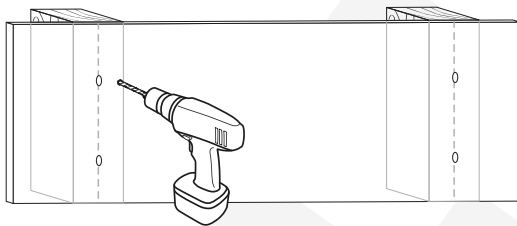
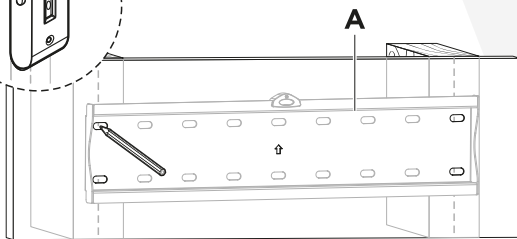
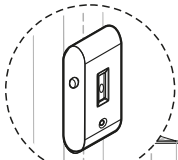
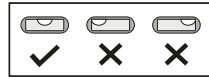

55mm (2.2") Ø 4.5mm (Ø 3/16")

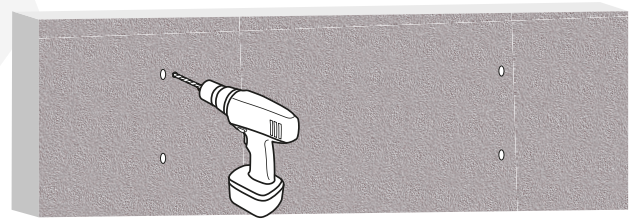
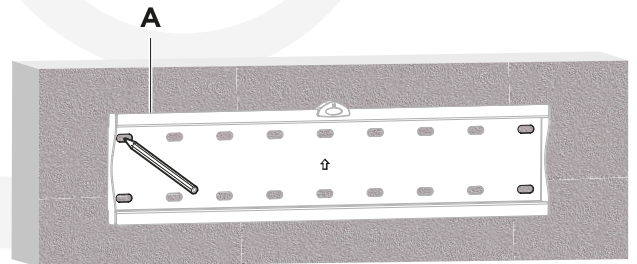
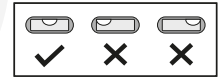
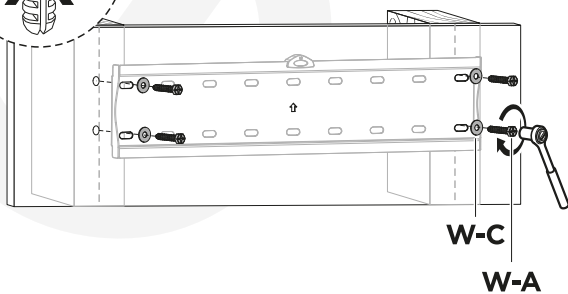

60mm (2.4") Ø 10mm (Ø 3/8")

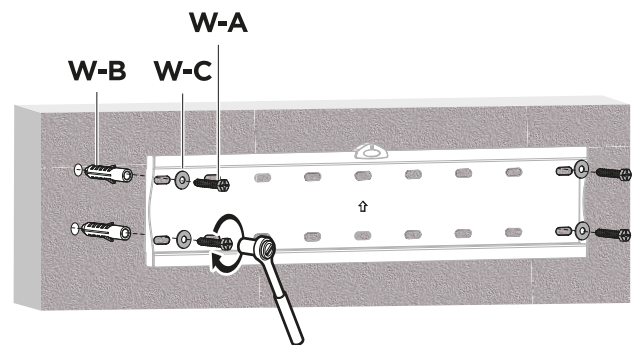

2

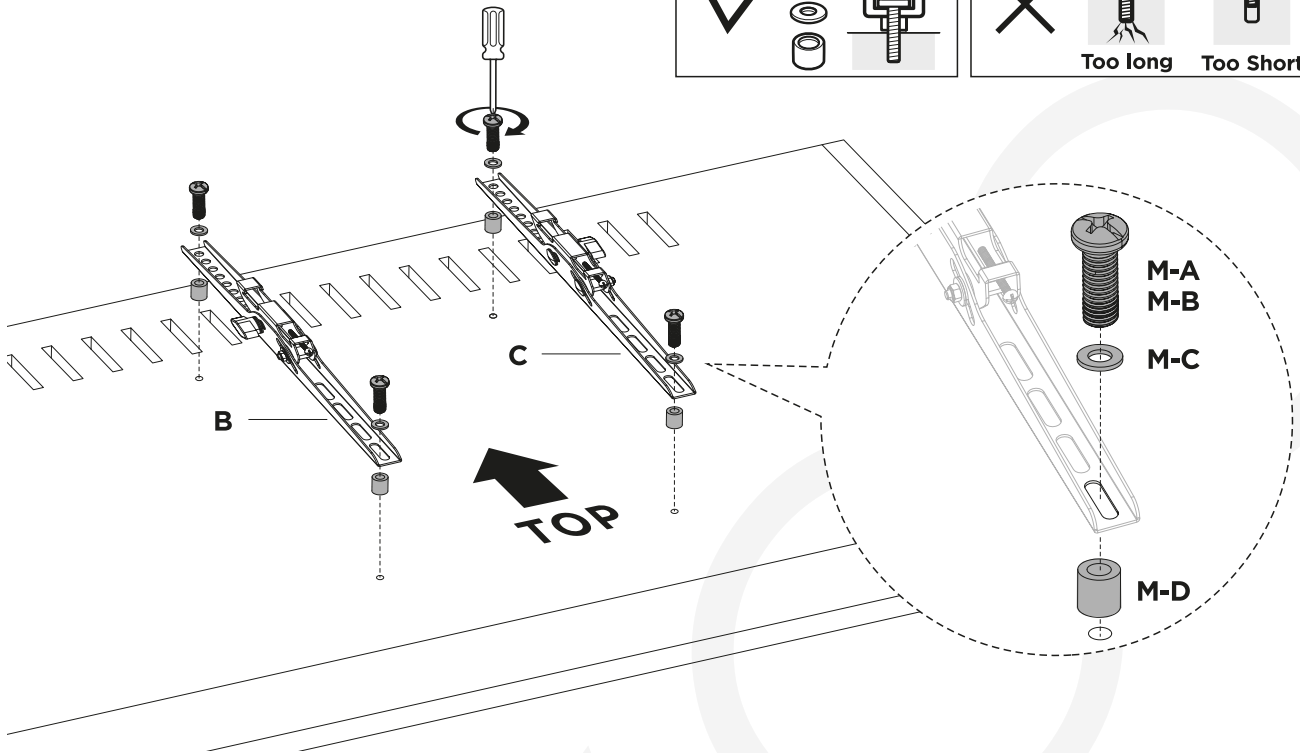
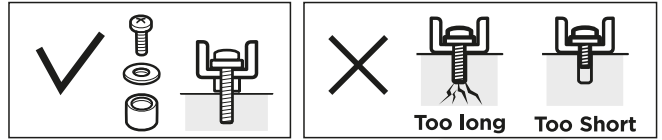

3

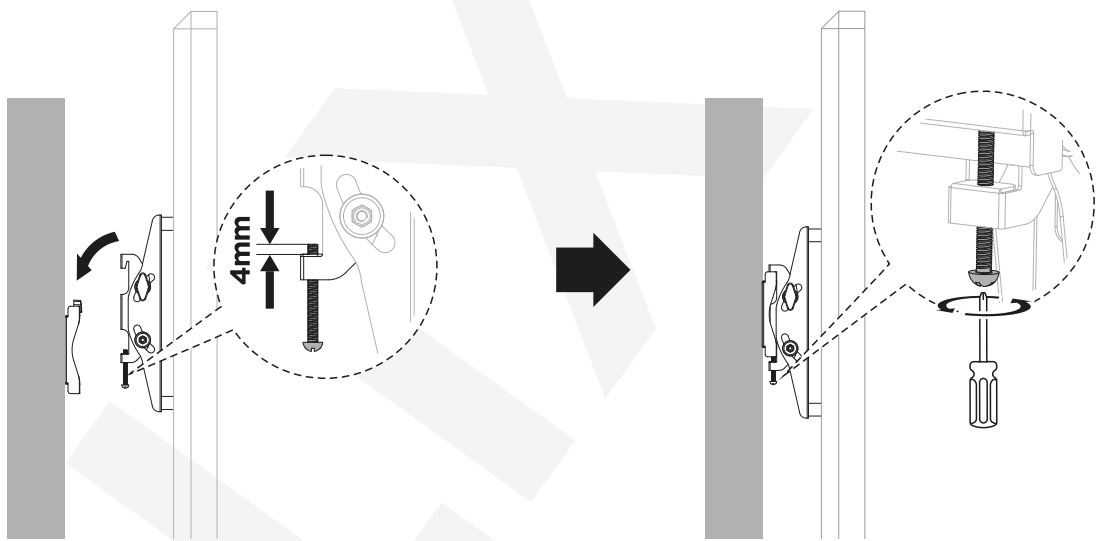

4

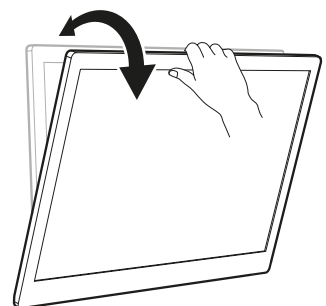
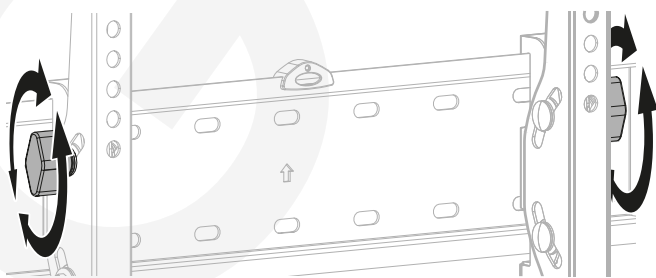

Note: Adjust to desired angle and then tighten the knobs as shown.