



ECO450

[32"-65"]



400X400



+3°~-3°

[45 KG]

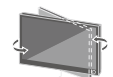

+60°~-60°



+5°~-15°



Distancia ajustable



Cerraduras de seguridad



nivel de pantalla ajustable

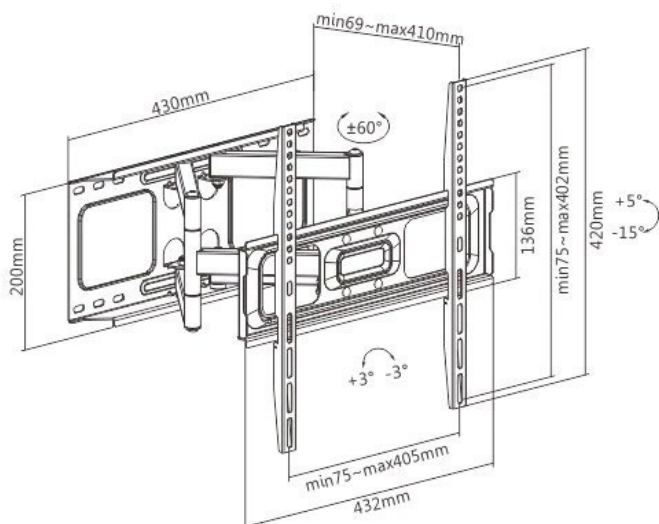

Item No.	ECO450
Compatible TV:	32-65 Pulg
Dimensiones:	410x435x420mm
VESA Compatible:	75x75,100x100,100x150, 100x200,150x100,150x150, 200x100,200x200,300x200, 300x300,400x200,400x300, 400x400mm
VESA Max:	400x400mm
VESA Min:	75x75mm
Carga:	45 kg
Brazo extendido:	69~410mm
Giro:	+60°~-60°
Inclinación:	+5°~-15°
Nivelación de pantalla:	+3°~-3°
Material:	Acero, Plástico
Acabado de la superficie:	Recubrimiento en polvo
Color:	Negro mate
Instalación:	Pared de Concreto o Drywall Reforzado
Indicador de dirección:	Si
Gestión de cables:	Si